			
Ecolabel (35°C / 55°C)		<b>A++ / A++</b>		Ecolabel (35°C / 55°C)	
Binnenunit	Type	<b>TSC14-500a</b>		Type	Unité intérieure
	Fabriekscode	<b>Low noise modus</b>			
		<b>023025/Combi 500a</b>		Code de fabrication	
Buitenunit	Type	<b>TOC14RIYF</b>		Type	Unité extérieure
	Fabriekscode	<b>WOYK150LJL</b>		Code de fabrication	
Koelmiddel		<b>R410A</b>			Réfrigérant
Verwarming Max. vermogen	Vermogen -7°C/35°C	kW	7,3	kW	Puissance -7°C/35°C
	Vermogen -7°C/45°C	kW	7,3	kW	Puissance -7°C/45°C
	Vermogen -10°C/35°C	kW	7,3	kW	Puissance-10°C/35°C
	Vermogen -10°C/45°C	kW	7	kW	Puissance-10°C/45°C
	Vermogen -15°C/35°C	kW	6,3	kW	Puissance-15°C/35°C
	Vermogen -15°C/45°C	kW	6,1	kW	Puissance-15°C/45°C
	Back-up incl.	kW	2x3	kW	Back-up incl.
Koeling		optie/option			Refroidissement
Besturings eenheid(x)	Waterdebiet nominaal	l/u	2339	l/h	Débit d'eau nominal
	Waterdebiet minimaal	l/u	1460	l/h	Débit d'eau minimal
	Werkdruk maximaal	Bar	3	Bar	Pression opérationnelle max.
	Wateruittrede min-max	°C	+8/+60	°C	Sortie d'eau min./max.
	Waterinhoud	L	24	L	Contenu eau
	Expansievat	L	8	L	Vase d'expansion
	Hoogte-breedte-lengte	mm	805-450-471	mm	Hauteur-largeur-profondeur
	Gewicht (leeg-gevuld)	kg	53-75	kg	Poids (vide-plein)
Opslag eenheid (x)	Kleur	RAL	9003	RAL	Couleur
	Elektr. bijverwarming SWW	kW	2	kW	Chauffage aux. ECS
	Isolatie Neopor	mm	95+100 Vlies	mm	Isolation Neopor
	Oppervlakte wisselaar	m <sup>2</sup>	3,08	m <sup>2</sup>	Surface échangeur
	Hoogte-Diameter	mm	2070-995	mm	Hauteur-largeur-profondeur
	Gewicht (leeg-gevuld)	kg	100-567	kg	Poids (vide-plein)
Buitendeel	Kleur	RAL	9003	RAL	Couleur
	Geluidsniveau op 5 m (+7°C/35°C)	dB(A)	25	dB(A)	Niveau sonore à 5 m (+7°C/35°C)
	Geluidsniveau op 5 m (-7°C/35°C)	dB(A)	41	dB(A)	Niveau sonore à 5 m (-7°C/35°C)
	Debiet (hoog)	m <sup>3</sup> /h	6250	m <sup>3</sup> /h	Débit (haut)
	Compressor		Twin Rotary LI		Compresseur
	Werkingslim. verwarmen	°C	-25/+35	°C	Plage de fonct. chauff.
	Hoogte-breedte-lengte	mm	1428-1080-480	mm	Hauteur-largeur/profond.
Elektr. install.	Gewicht	kg	138	kg	Poids
	Kleur (benadering)	RAL	1013	RAL	Couleur (approximative)
	Voeding	V	400V/3F+N	V	Alimentation
	Stroom max. verwarmen	A	14	A	Amp. max chauffage
	Zekering traag	A	20	A	Fusible retardé
	Hoofdvoeding aanbr. op		buiten/ext.		Unité à alimenter
	Sectie voedingskabel	mm <sup>2</sup>	5G2,5	mm <sup>2</sup>	Section câble alimentation
	Sectie tssn bi en bu	mm <sup>2</sup>	4G1,5	mm <sup>2</sup>	Section entre int. et ext.
	Voeding cv bijverwarming (*)	V	230/1		Alimentation ch. aux. Chauffage (*)
	Zekering cv bijverwarming (*)	A	16/32		fusible chauffage ch. aux. (*)
Tech. install.	Sectie cv bijverwarming (*)	mm <sup>2</sup>	3G2,5/3G6		section ch. aux. Chauffage (*)
	Voeding SWW	V	230/1F	V	Alimentation ch. aux. ECS
	Zekering SWW	A	16	A	Fusible ECS ch. aux.
	Sectie SWW	mm <sup>2</sup>	3G2,5	mm <sup>2</sup>	Section ch. aux. ECS
	Hydr. aansluiting binnendeel	inch	1"	inch	Raccordement hydraulique
	Diameter hoofdleiding	inch	5/4"	inch	Diamètre tuyau principal
	Expansie		buiten/ext.		Détente
	Zuigleiding bi/bu	inch	5/8	inch	Diamètre gaz int/ext
	Vloeistofleiding bi/bu	inch	3/8	inch	Diamètre liquide int/ext
	Standaardvulling (CO <sub>2</sub> -eq)**	kg-m (kg)	3.8-15 (7934)	kg-m (kg)	Charge standard (CO <sub>2</sub> -eq)**
Bijvulling (CO <sub>2</sub> -eq)**	g/m (kg)	50 (104)	g/m (kg)	Charge supplémentaire (CO <sub>2</sub> -eq)**	
Min./Max. leidinglengte	m	5-30	m	Longueur min./max. tuyaux	
Hoogteverschil max	m	15	m	Dénivelé max	
Diam. condensafvoer bi/bu	mm	32/16	mm	Diam. évac. condensat bi/bu	

(\*) gegevens volgens de norm EN14511 - Suivant la norme EN14511

(\*\*) Gerekend met een GWP-waarde van 2088 voor R410a - Calculé avec une GWP-valeur de 2088 pour R410a

(x) De besturings- en de opslageenheid vormen samen 1 werkend toestel dat geschikt is voor CV en productie van SWW.

De opslageenheid kan niet functioneren zonder de bijhorende besturingseenheid.

Ensemble, l'unité de contrôle et l'unité de stockage forment un seul appareil adapté au chauffage de locaux et à la production d'eau chaude sanitaire.

(\*) De elektrische weerstand is inclusief en kan als 3 kW of als 2 x 3kW worden aangesloten - La résistance électrique est inclus et peut être raccordé 3 kW ou 2x 3kW

# Thermastage

ERP gegevens	Temperatuuroepassing	°C	55	°C	Application température	Valeurs ERP
	Energieklasse ruimteverw.		A++		Classe énergétique chauffage espace	
	Nominaal vermogen	kW	16	kW	Puissance nominale	
	Jaarlijks energieverbruik (CV)	kWh	9915	kWh	Consommation annuelle (CV)	
	Opw. Rendement ruimteverw.	%	130	%	Rendement chauffage espace	
	Werking "off peak" mogelijk		ja		Fonctionnement "off peak" possible	
	Energieklasse SWW		A		Classe énergétique ECS	
	Tapprofiel		XXL		Profil de soutirage	
	Jaarlijks elektriciteitsverbruik (SWW)	kWh	1771	kWh	Consommation annuelle d'électricité (EC)	
	Opwekkingsrendement SWW	%	121	%	Rendement eau chaude sanitaire	
	Netto inhoud SWW	L	467	L	Capacité d'eau utilier	
Elektr. bijverwarming SWW	kW	2	kW	Résistance électrique boiler		

Besturingseenheid + opslageenheid

Unité de gestion + unité de stockage

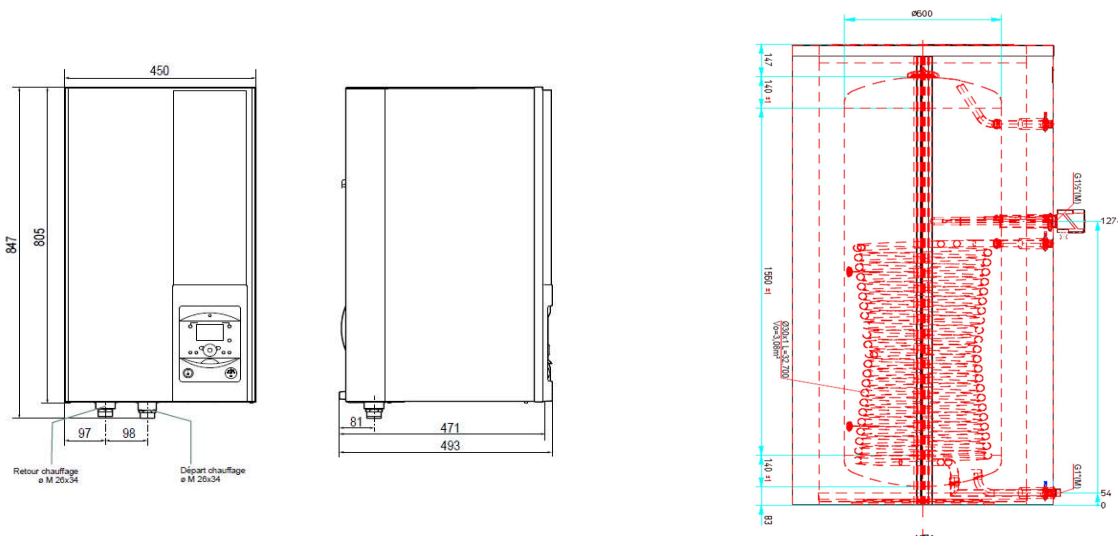

Buitendeel

Unité extérieure

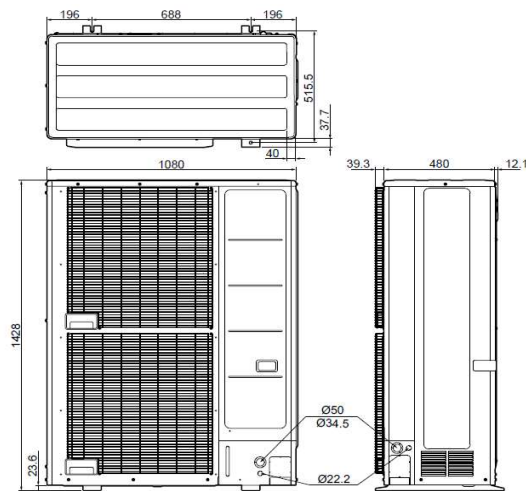

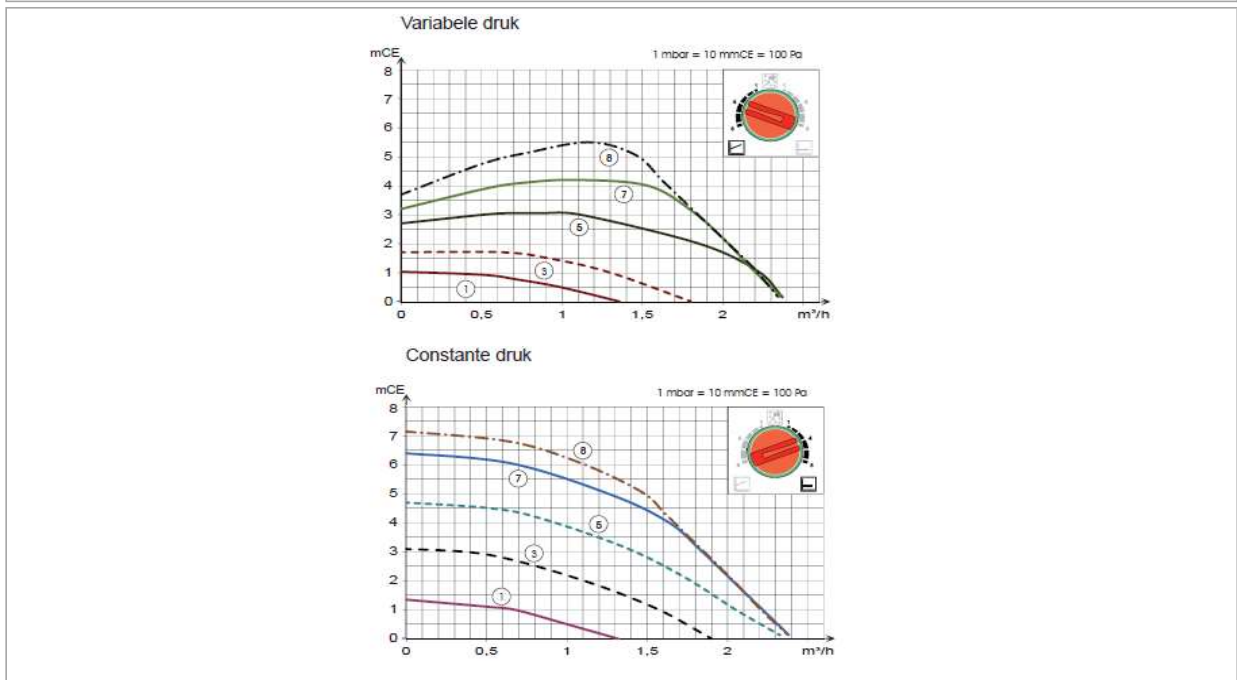
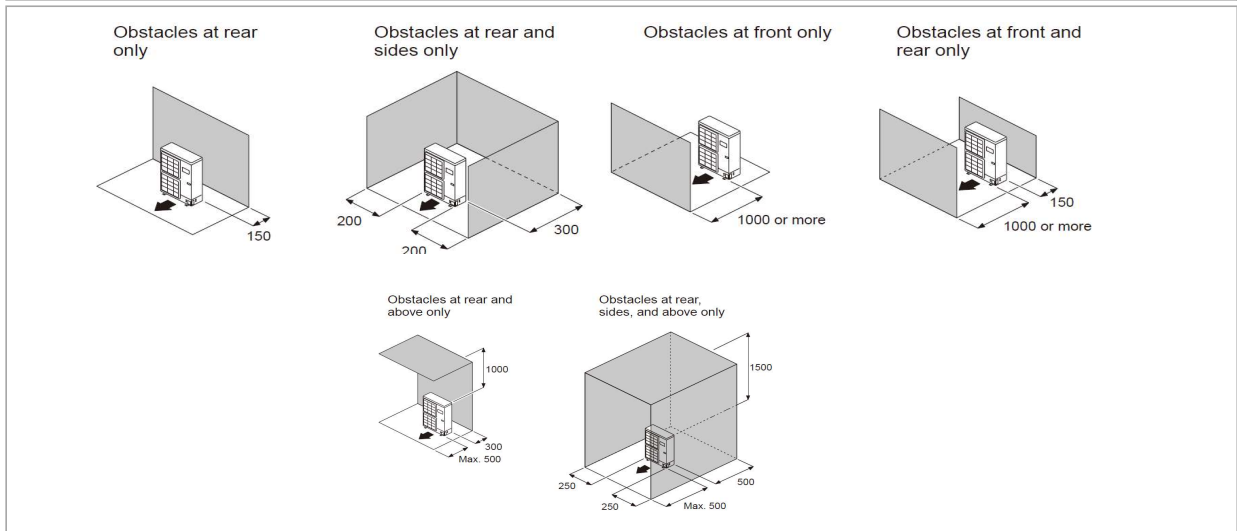

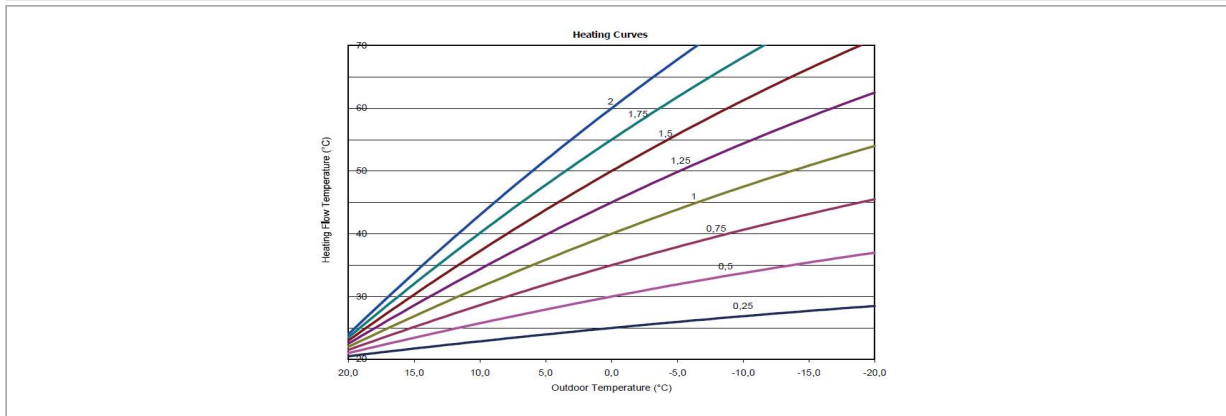





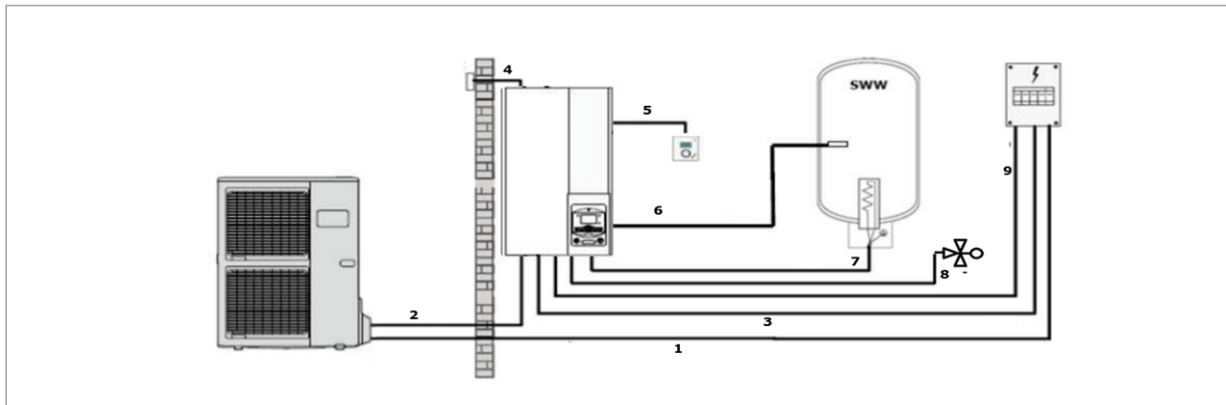



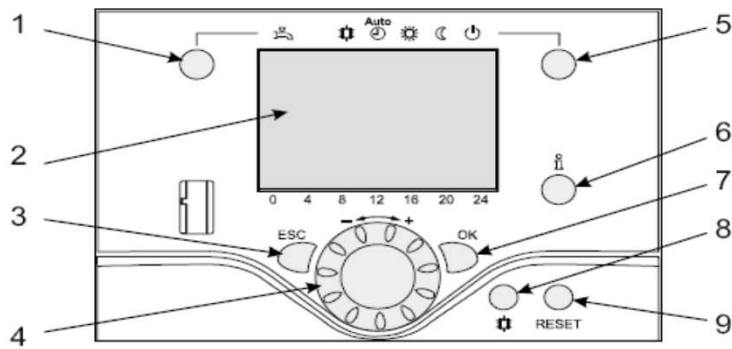



Elektrische aansluiting

Connections électriques



1	Voedingskabel buitendeel	400V/3F+N	5G2.5mm <sup>2</sup>	Câble d'alimentation unité extérieure
2	Verbindingskabel buitendeel-binnendeel		4G1.5 mm <sup>2</sup>	Câble entre int. et ext.
3	Voedingskabel backup CV (3kW)		3G2.5mm	Câble d'alim. rés. elec. Ch. (3kW)
4	Buitenvoeler		2G0.75mm <sup>2</sup>	Sonde extérieure
5	Kamerthermostaat UTW-C55XA		2G0.75mm <sup>2</sup>	Thermostat intérieur UTW-C55XA
6	Meetsonde SWW boiler (incl.)		2G0.75mm <sup>2</sup>	Sonde ch. aux. ECS (incl.)
7	Verbindingskabel binnendeel-backup SWW		3G2.5mm <sup>2</sup>	Câble entre int. et résistance électrique ECS
8	Kabel 3-weg ventiel (incl.)		2G0.75mm <sup>2</sup>	Câble vanne à trois-voies (incl.)
9	Voedingskabel backup SWW (2kW)		3G2.5 mm <sup>2</sup>	Câble d'alimentation résistance électrique ECS 2 kW



Ref.	Function	- Definitions
1	Selection of the DHW operating regime (Domestic hot water)	- If the installation is fitted with a DHW tank.  - ON: Production of DHW according to the time program. - Off: Preparing the domestic hot water for stopping with the anti-frost function active. - Boost: Hold down the DHW key for 3 seconds. Immediate DHW operation after use of the electrical back-ups until the DHW comfort setting has been reached
	 ON  ON  Off  Off	
2	Digital display	- Operating control. Readout of the current temperature, of the heating regime and of any faults  . - View the settings
3	Exit "ESC"	- Quit the menu.
4	Navigation and setting	- Selecting the menu. - Setting parameters. - Adjusting the ambient temperature setpoint.
5	Selecting the heating regime	-  Heating operating according to the heating programme (Summer/winter mode switchover is automatic). -  Constant comfort temperature. -  Constant reduced temperature. -  Stand-by regime with anti-frost protection (Provided that the heat pump's electrical power supply is not interrupted).
6	Information display	- Various data (please see page 59). -  Reading error codes (please see page 57). -  Information concerning maintenance, special regime.
7	Confirm "OK"	- Input into the selected menu. - Confirmation of the parameter settings. - Confirmation of the adjustment to the comfort temp. setting.
8	Selecting cooling mode	- If the installation is fitted with the cooling kit: -  Cooling operating according to the heating programme (Summer/winter mode switchover is automatic).
9	RESET button (Hold down the "RESET" key for 3 seconds).	- Reinitialising the parameters and cancelling error messages. Do not use during normal operation.

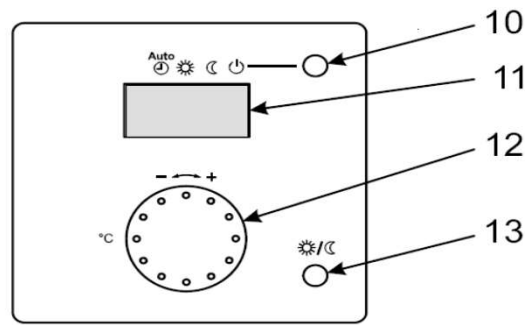

Ref.	Function	- Definitions
10	Selecting the heating regime	<ul style="list-style-type: none"> <li>-  Heating operating according to the heating programme (Summer/winter mode switchover is automatic).</li> <li>-  Constant comfort temperature.</li> <li>-  Constant reduced temperature.</li> <li>-  Stand-by regime with anti-frost protection (Provided that the heat pump's electrical power supply is not interrupted).</li> </ul>
11	Digital display	- Operating control. Readout of the current temperature, of the heating regime and of any faults .
12	Control knob	- Adjusting the ambient temperature setpoint
13	Presence key	- Comfort / Reduced switchover